

hyperston  [®]



Company Introduction
Value Added SD Card Application using
hy-API



efficiency embedded

hyperston ®



Supplier of Flash Controllers for a variety of interfaces, including SD

Over 25 years of experience

Development and Design at Headquarters in Germany

Global supplier with offices in USA & Asia



efficiency embedded

hyperston

Safe. Reliable. Secure.



Guaranteed no data corruption, safe system operation



Reliable in extreme environments and use-cases, using hyMap[®], a proprietary sub-page based flash management FW



Secure Access and digital rights management

 **SD Association**

efficiency embedded

hyperston®





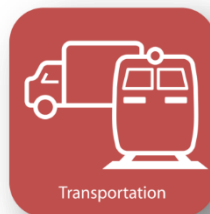



High-reliability Flash management across a wide range of markets





API (Application Programming Interface)

-  Full customer control of value added features, no disclosure to Hyperstone needed
-  Benefit from using state-of-the-art Flash management FW including hyMap[®]
-  Independent development of Flash Management FW & custom application FW
-  Easy Maintenance of Customer Firmware Extension (CFE) through Vendor Commands
-  API resources available to download from the Hyperstone Website
-  API kit includes HW, SW tools, development board and documentation

hyperston ®

Wibu-Systems implemented Hyperstone's Flash Controllers in their SD CodeMeter hardware to offer more security



Their Customer Firmware Extension (CFE) implemented additional secure encryption and license key management features that enhanced their CmDongles and provided the highest level of security



efficiency embedded

hyperston[®]

Hyperstone controllers using an API implementation are ideal for many value added products to serve a variety of markets

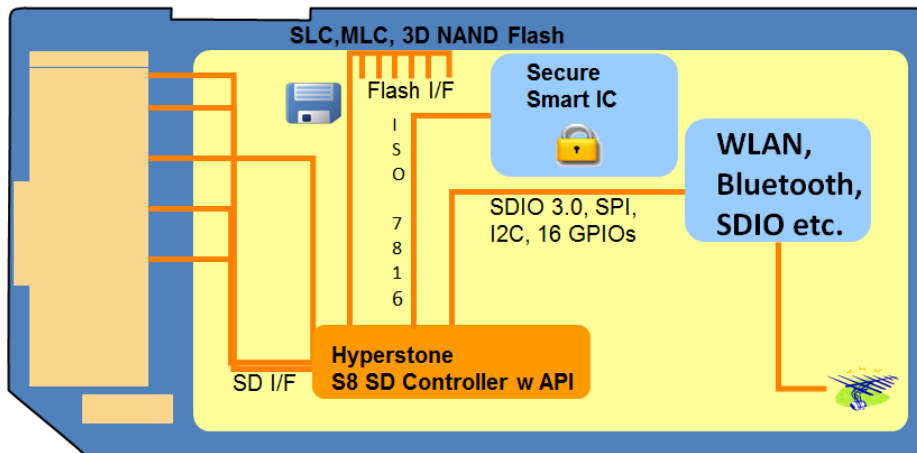

Lets discuss your application to see what can be done